

SPECIFICATIONS

SS-1200NP-ML500* CC DRIVER

Model: SS-1200NP-ML500*

Power: 1200W

Rev.: V01

Release date: 2026-05-29

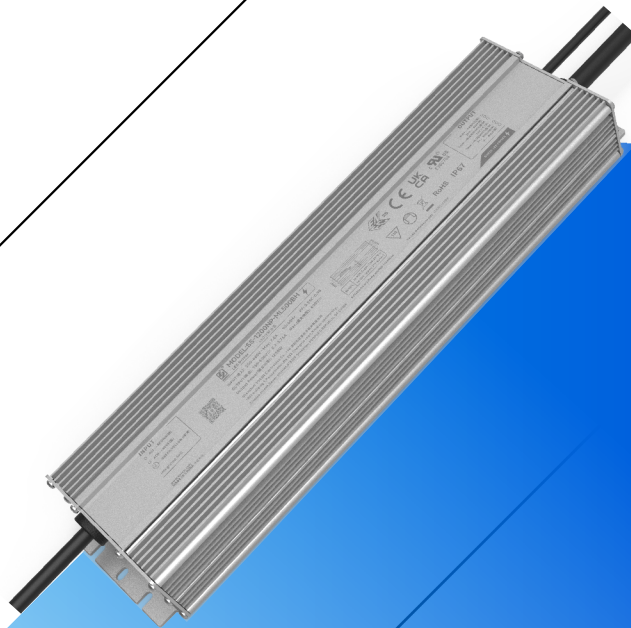

SS-1200NP-ML500 Series LED Driver

Features

- Efficiency up to 97%
- Dimming: 0-10V,PWM,Resistor,Timing
- Surge protection: CM: 6kV, DM: 6kV
- AUX Power: 12V/0.3A
- Constant Lumen, Life Warning
- NTC
- Standby Power<0.5W
- IP67
- Communication with PC
- Protections: SCP/OTP/UVP/OPP
- Warranty: 5years



IP67 RoHS

Description

SS-1200NP-ML500* is 1200W non-isolated constant current LED driver with 180-528Vac input and wide O/P voltage range and adjustable O/P current by program. LED luminaire manufactures can easily design luminaires and reduce cost

Applications:

Horticulture lighting, Stadium lighting, Fish lighting

Model List:

Model	AC Input Range	Max. Pout	Vout Range	Full Power Vo Range	Iout	THD (Typ.)	PF(Typ.)	Eff.(Typ.)	Max.Tc
SS-1200NP-ML500*	180-528Vac	1200W	150-500V	252-500V	0.7-4.76A	10%	0.95	97%	90°C

Note:

1.Default Tested: at 400Vac, Ta 25°C;

2.The performance of the LED Driver can be guaranteed within the full power Vo range. The voltage lower than full power Vo range, it is need to test the performance with the LED module ;

SS-1200NP-ML500 Series LED Driver

“*” Means Additional Function

“*”	AUX 12V (suffix:H)	NTC (suffix:N)	Timing	0-10V/PWM Dim /Resistor (suffix:B)	Output- Ground	Remark
BH	✓		✓	✓		
BHN	✓	✓	✓	✓		
BH-G	✓		✓	✓	✓	
BHN-G	✓	✓	✓	✓	✓	

Input Characteristics:

Parameter	Min.	Typ.	Max.	Remark
Rated AC Input Range	200Vac		277Vac	<Ta:45°C
	277Vac		480Vac	<Ta:50°C
AC Input Range	180Vac		528Vac	
Input Frequency Range	47Hz	50/60Hz	63Hz	
Max Input Current			7.0A	200Vac, Full load
Max Input Power			1400W	200Vac, Full load
Max Inrush Current(220Vac)			50A	Cold start
Max Inrush Current(347Vac)			50A	Cold start
Max Inrush Current(400Vac)			60A	Cold start
Max Inrush Current(480Vac)			70A	Cold start
Standby Power			0.5W	230Vac/50Hz, Dim-off
Power Factor	0.95	0.97		220Vac/50Hz, Full load
	0.90			200-480Vac, 70-100% load
THD		8%	10%	347Vac/60Hz, Full load
			20%	200-480Vac, 70-100% load

SS-1200NP-ML500 Series LED Driver

O/P Characteristics:

Parameter	Min.	Typ.	Max.	Remark
O/P Voltage Range	150V		500V	Power derated @150-252V
Rated O/P Voltage	252V		500V	$P_o=V_o \cdot I_o=1200W$, Full load
Rated O/P Current	2.4A		4.76A	4.76A for 252V, 2.4A for 500V
Adj. O/P Current (AOC) Range	0.7A		4.76A	Adjustable by program
No Load Voltage			600V	
Efficiency @220Vac	92.0%	94.0%		O/P 500V/2.4A
Efficiency @347Vac	94.5%	96.5%		O/P 500V/2.4A
Efficiency @400Vac	95.0%	97.0%		O/P 500V/2.4A
Efficiency @480Vac	95.0%	97.0%		O/P 500V/2.4A
O/P Current Tolerance	-5%		+5%	
O/P Current Ripple(PK-AV)		5%	10%	Full load
Start-up Current Overshoot			10%	Full load
Start-up Time			0.5S	230Vac, Full load
Line Regulation	-2%		+2%	Full load
Load Regulation	-2%		+2%	
Temperature Coefficient	-0.03%/°C		+0.03%/°C	$T_c: 0^{\circ}C \sim 90^{\circ}C$
OTP	90°C		100°C	Drop current when OTP, and it can be automatically restored after the abnormality is removed.
Short Circuit Protection				Driver will not be damaged, current mode

SS-1200NP-ML500 Series LED Driver

Other Characteristics:

Parameter		Min.	Typ.	Max.	Remark
AUX Power	O/P Voltage	10.8V	12V	13.8V	
	O/P Current			300mA	
0-10V Dimming (Optional)	Dim Vmax	0V		12V	Negative dimming by programming Dimming prohibits reverse connection. DIM+ source current 110uA .
	Dim Range	10%loset		100%loset	
	Rec.Dim Range	0V		10V	
10-0V Dimming (Optional)	Rec.Dim Range	0V		10V	DIM+ Maximum sink current is 40uA Dimming prohibits reverse connection. 5-0V by programming
PWM Dimming (Optional)	PWM High	9.8V		10.2V	
	PWM Low	0V		0.3V	DIM+ source current 110uA .
	Frequency	1KHz		2KHz	Dimming prohibits reverse connection.
	PWM Duty	0%		100%	
Resistor Dimming (Optional)	Resistance	0Kohm		100Kohm	
	Dim Range	10%loset		100%loset	DIM+ source current 110uA .
0-10V Dim to Off	Dim off	7%	8%	9%	By DC voltage, PWM, resistance dimming ratio
	Dim on	8%	9%	10%	By DC voltage, PWM, resistance dimming ratio
NTC Founction(Optional)		By programming			External resistance value 10K Ω , B value 3950 or 3435 NTC thermistor, set parameters through corresponding programs
Timing Curve(Optional)		By programming			Set by program
Constant Lumen(Optional)		By programming			Set by program
Life Warning(Optional)		By programming			Set by program
Life Time(Tc \leq 75 $^{\circ}$ C)		\geq 50,000 hours			80% Load, 400Vac
MTBF		198,700 hours			400Vac,Full load, Ta=25 $^{\circ}$ C (MIL-HDBK-217F)
IP Grade		IP67			
Tc		90 $^{\circ}$ C			
Warranty		5 years			Tc 75 $^{\circ}$ C
Net Weight		2705g			
Dimension		350mm*89.5mm*44.5mm			L x W x H

NOTE:

- All the parameters above are tested Ta 25 $^{\circ}$ C and LED load, unless specified.
- When using resistor dimming (parallel connection of dimming wires), if the number of parallels is: N, the dimming resistor should be realized 0-100% dimming range, resistance value: 91K Ω /N.

SS-1200NP-ML500 Series LED Driver

Environmental Requirements

Parameter	Min.	Typ.	Max.	Remark
Operating Temperature(Tcase)	-40°C	25°C	+90°C	
Storage Temperature	-40°C	25°C	+90°C	
Operation Humidity	10%RH		90%RH	
Storage Humidity	5%RH		95%RH	
Altitude	-65m		4000m	

Safety and EMI/EMS Standards

Certification	Standard	Status	Remark
UL/CUL	UL8750	✓	
ENEC	EN 61347-1 EN 61347-2-13 EN IEC62384	✓	
RCM	AS/NZS61347.2.13		
UKCA	EN 61347-1 EN 61347-2-13 EN 62493	✓	
CCC	GB19510.1:GB19510.14		
CE	EN 61347-1 EN 61347-2-13 EN 62493	✓	

EMI/EMS	Criterion	Remark
Conduction Emission	EN IEC 55015	
Radiation Emission	EN IEC 55015	
Harmonic Current Emissions	IEC/EN 61000-3-2	Class C
Surge	IEC/EN61000-4-5	DM: 6kV,CM: 6kV,Criterion B
	ANSI/C82.77-5	DM: 6kV,CM: 6kV,Criterion B
Ring Wave	IEC/EN 61000-4-12;ANSI/C82.77-5	DM: 6kV,CM: 6kV,Criterion B

SS-1200NP-ML500 Series LED Driver

Safety Test Items:

Safety Test Items	Technical Indicators		Remark
Insulation Requirements	UL Insulation Requirements	ENEC Insulation Requirements	
Input-Case	2U+1000	2U+1000	Basic insulation
Input-Dim	2U+1000	4U+2000	UL Basic insulation ENEC Reinforced insulation
Dim-Case	500Vac	500Vac	Basic insulation
Insulation Resistance	$\geq 10M\Omega$		Input-DIM, Test voltage: 500Vdc
Ground Resistance	$\leq 0.1\Omega$		25A/1min
Leakage Current	$\leq 0.75mA$		480Vac

NOTE:

1. SOSEN warrants the LED Driver itself complies with EMC standard. However, LED Driver's EMC should be re-checked when integrated into lighting systems due to unexpected interference as component.
2. Please short (ACL and ACN), (V+ and V-), (Dim+ and Dim - and Vaux+) when Hi-pot test (Turn off ARC).
3. When applying withstand voltage to ground, the input and output wires are shorted together to withstand voltage to ground.

Performance Curves:

Input Inrush Current

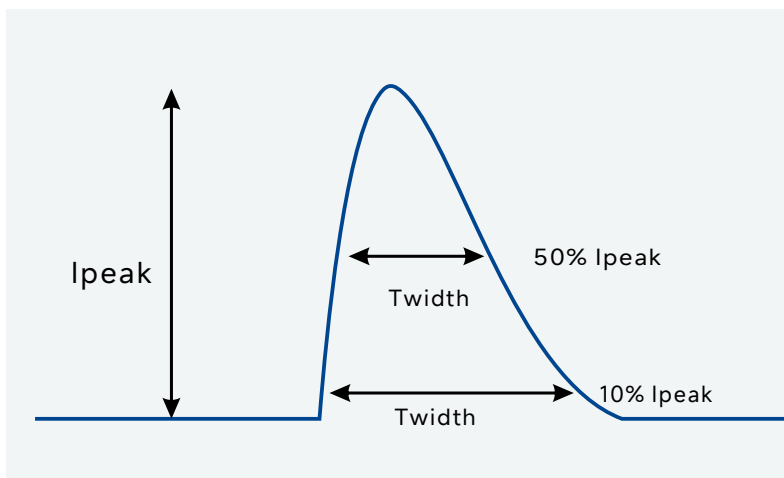

Vin	Ipeak	T(@10% of Ipeak)	T(@50% of Ipeak)
220Vac	50A	10mS	3mS
347Vac	50A	11mS	4mS
400Vac	60A	12mS	4mS
480Vac	70A	12mS	4mS

SS-1200NP-ML500 Series LED Driver

Performance Curves:

O/P Voltage Vs. O/P Current(Dim/AOC Window)

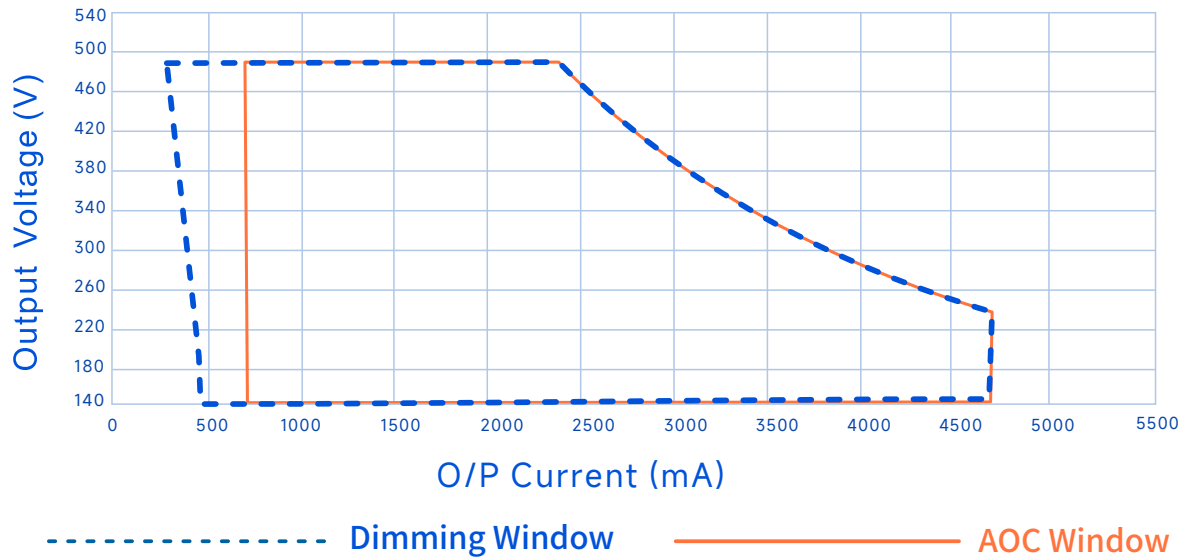

SS-1200NP-ML500 Series LED Driver

Performance Curves:

Efficiency Vs. O/P Voltage ($V_{in}=220V_{ac}$)

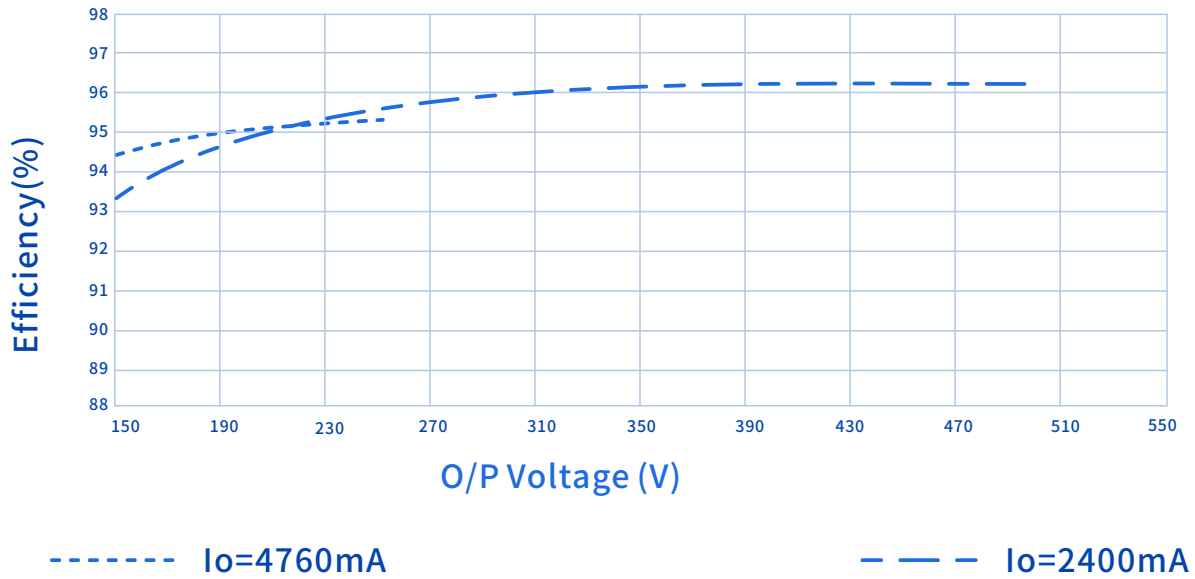

Efficiency Vs. O/P Voltage ($V_{in}=347V_{ac}$)

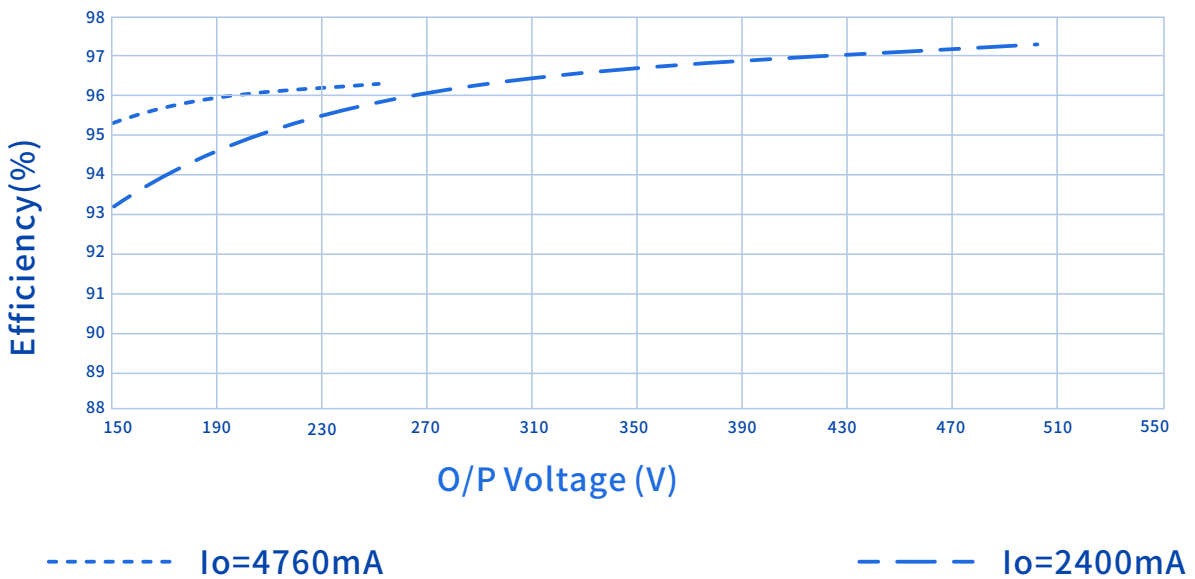

SS-1200NP-ML500 Series LED Driver

Performance Curves:

Efficiency Vs. O/P Voltage ($V_{in}=400V_{ac}$)

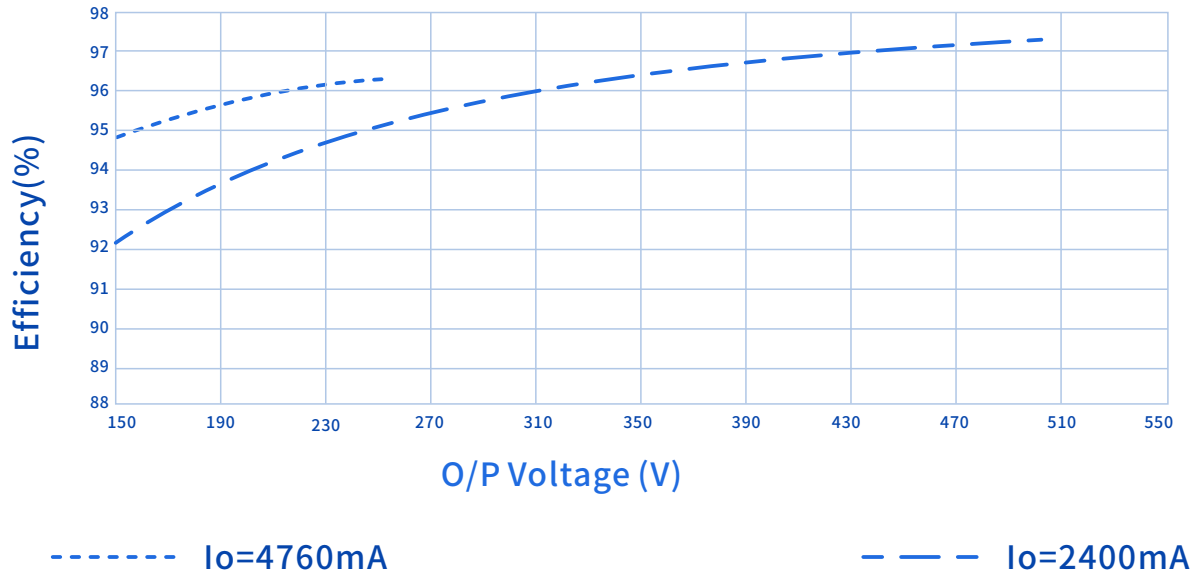

Efficiency Vs. O/P Voltage ($V_{in}=480V_{ac}$)

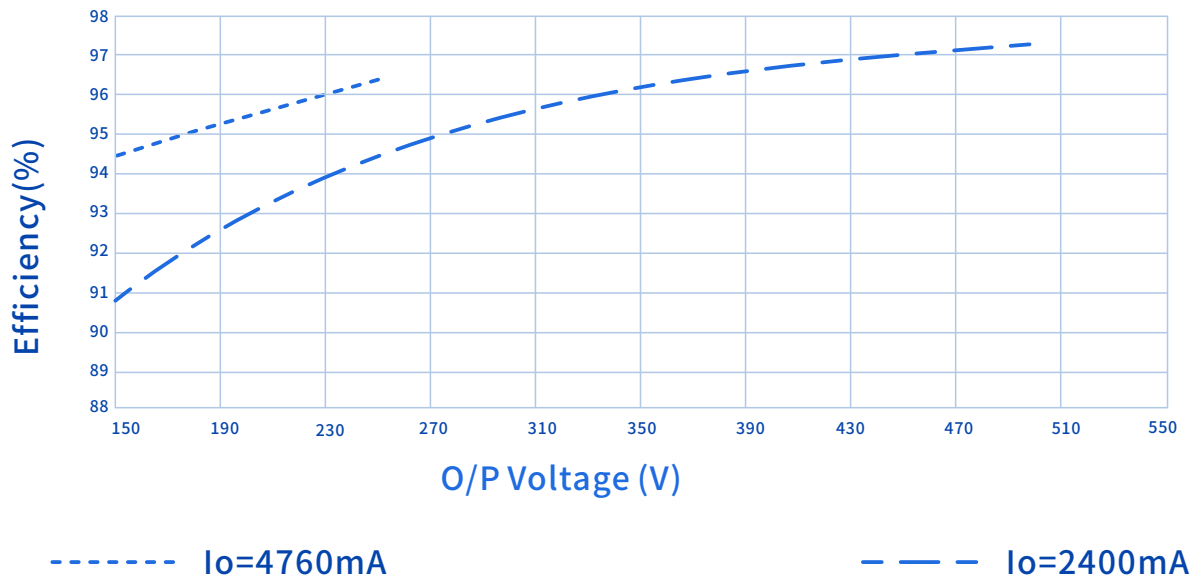

SS-1200NP-ML500 Series LED Driver

Performance Curves:

Power Factor Vs. O/P Power

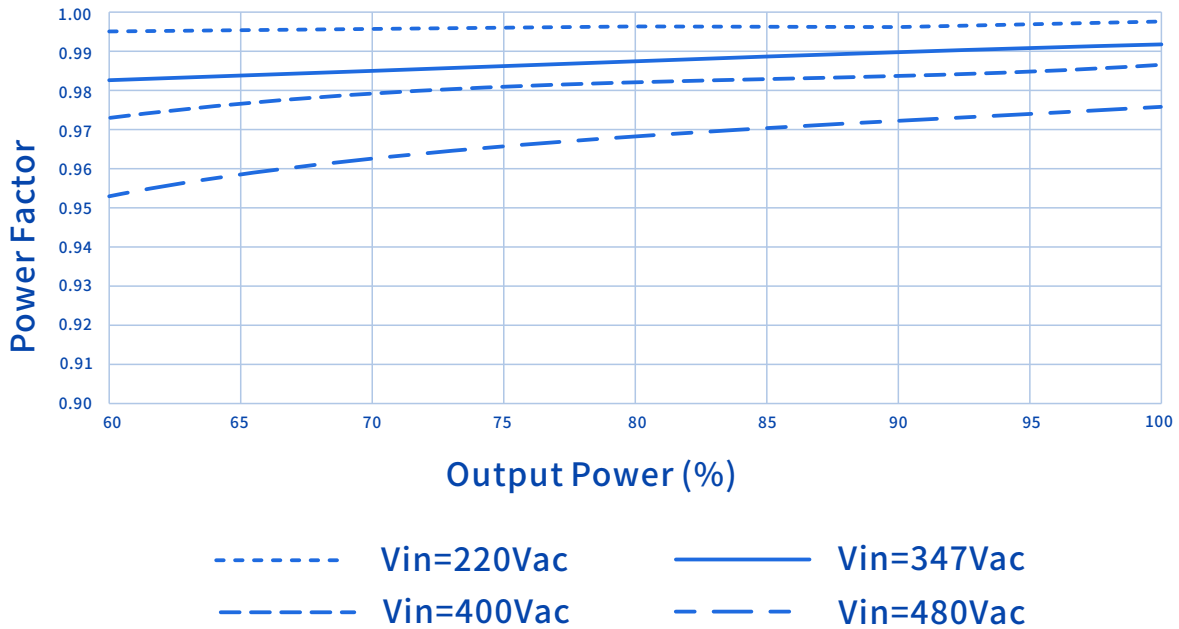

THD Vs. O/P Power

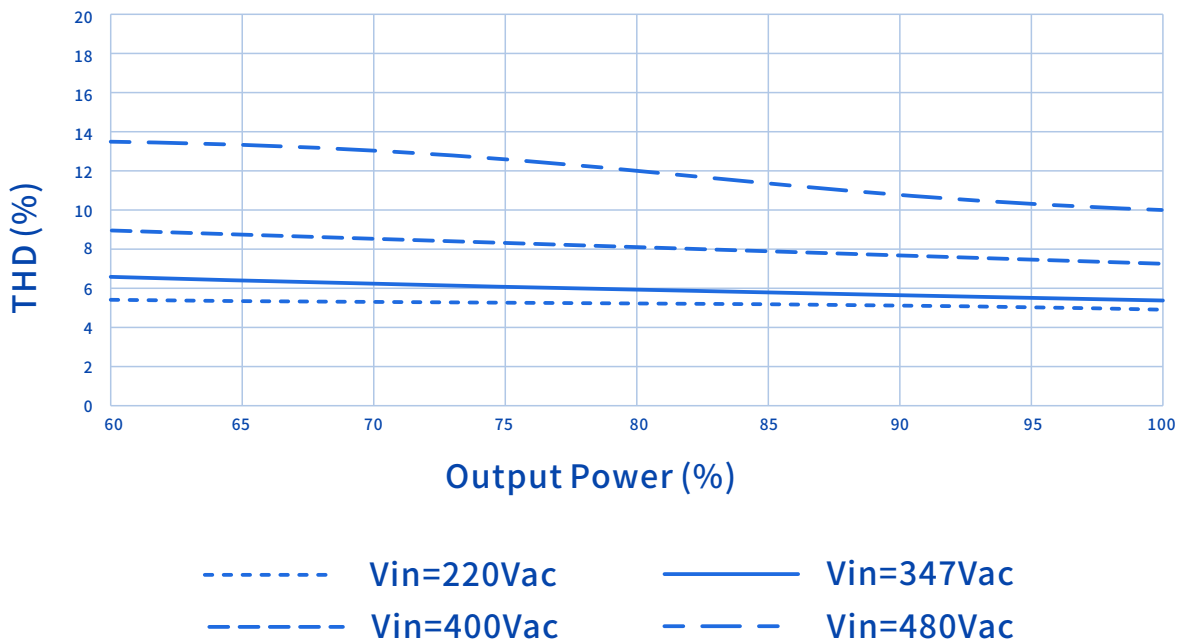

SS-1200NP-ML500 Series LED Driver

Performance Curves:

O/P Power Vs. Input Voltage

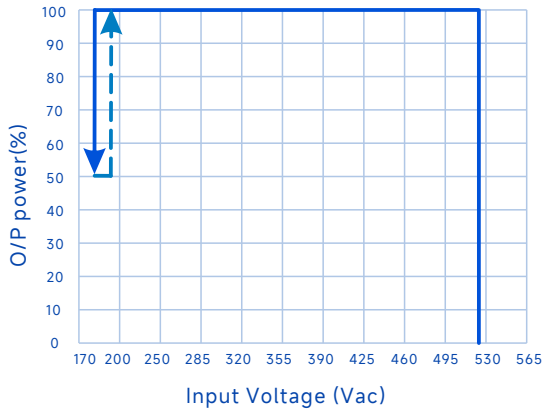

O/P Power Vs. Case Temperature

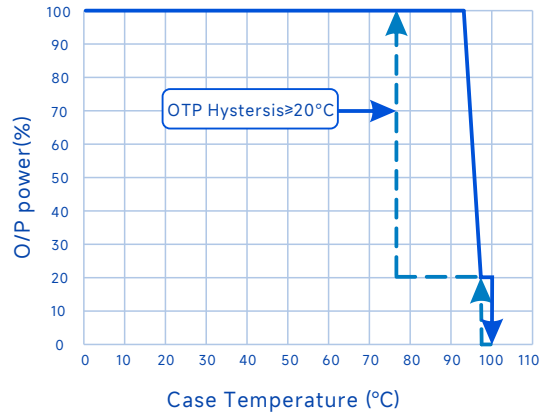

O/P Power Vs. Dimming

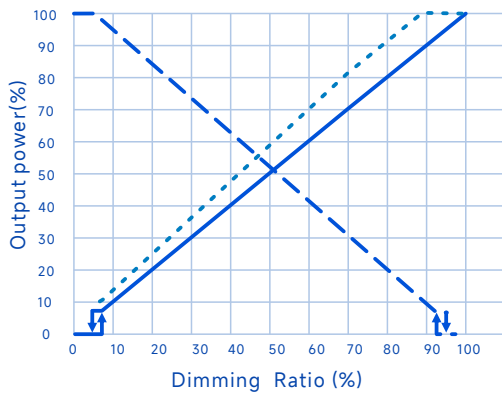

Lifetime Vs. Case Temperature

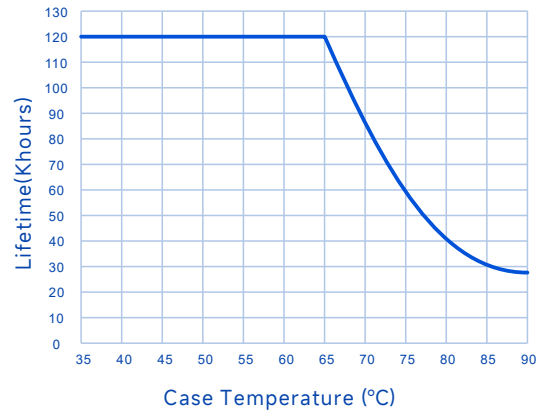

- 0-10V, 0-5V, PWM
- - - 10-0V, 5-0V
- Resistor Dimming(100KΩ)

Programming connection diagram

Legacy Timer: Driver's O/P follows the pre-programmed timing curve after turn-on.
Auto-Adjust by Percentage: Driver's O/P will be adjusted by automatically changed dimming curve by the period percentage based on the latest 5 dimming curve.
Auto-Adjust by Mid-point: Driver's O/P will be adjusted by automatically changed dimming curve by mid-point based on the latest 5 dimming curve.

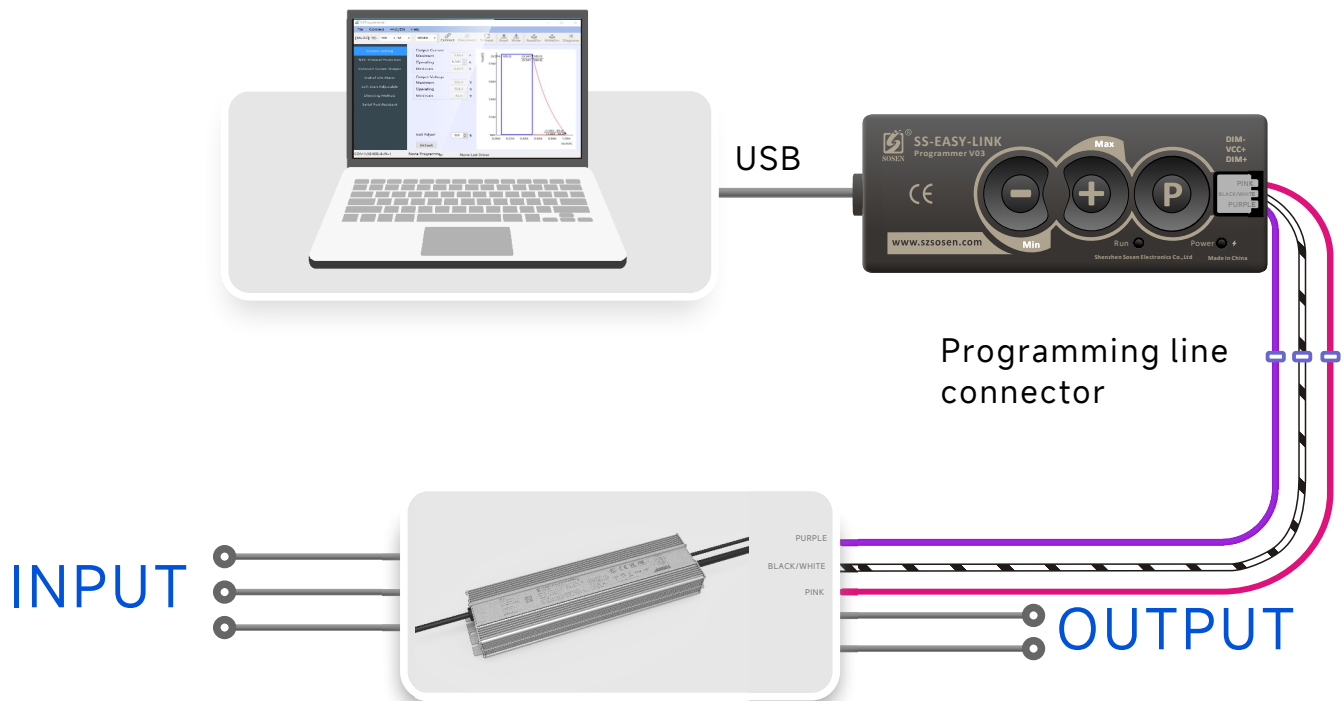

Constant Lumen Output

Constant Lumen Output are design to maintain fixture's stable output lumen by increasing driver's output current within driver's life span to counteract LED lumen degradation.

SS-1200NP-ML500 Series LED Driver

Parameter			Remark
Default setting	Positive logic dimming (0-10V)	Dimming voltage default 10V (source current)	Factory Default Model
	Negative logic dimming (10-0V)	Dimming voltage default 0V (sink current)	Optional
Dimming optional function	Positive logic dimming (0-10V)	Dimming voltage default 0V (sink current) Resistance dimming not available	When the dimming wire is not connected, the LED driver is not output
			For parallel dimming applications with multiple LED drivers, it is recommended to use the sink current mode (to be noted in the order)

Note:

Select "Dimming voltage defaults to 10V (source current)" / "Dimming voltage defaults to 0V (sink current)", which needs to be set according to the dimmer used by the end user.

Settings Interface

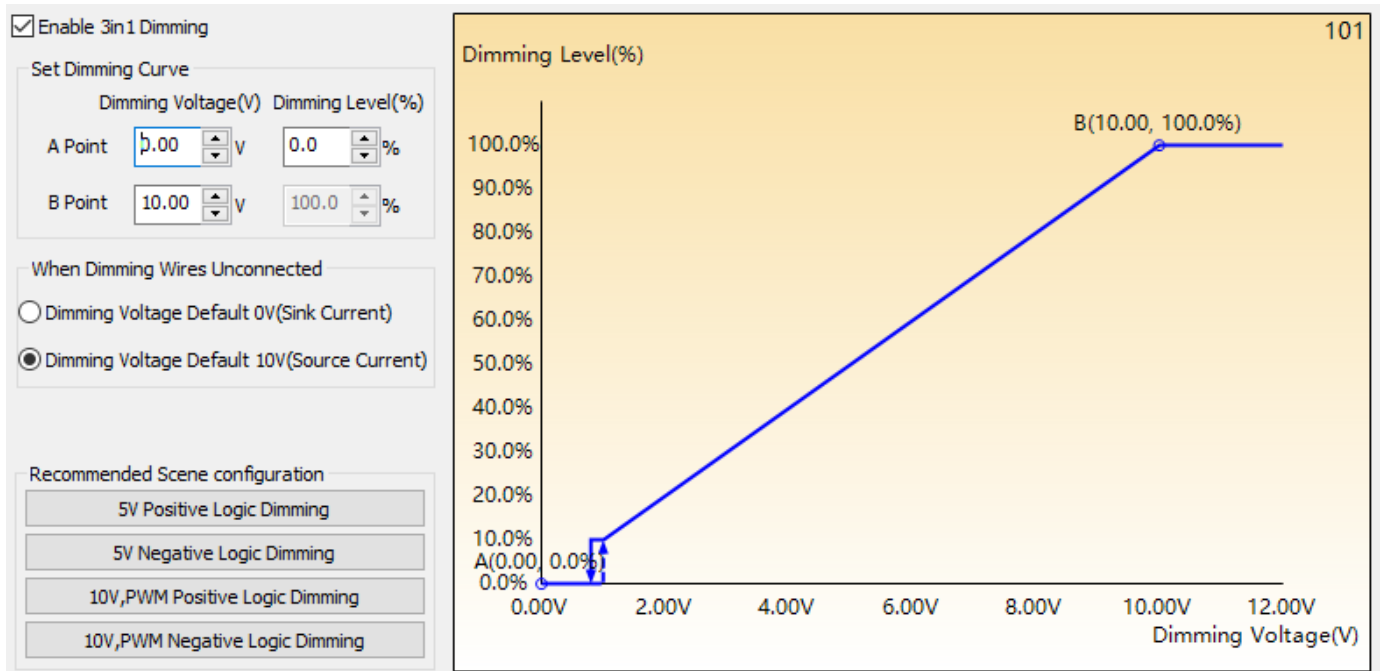

SS-1200NP-ML500 Series LED Driver

Mechanical Characteristics

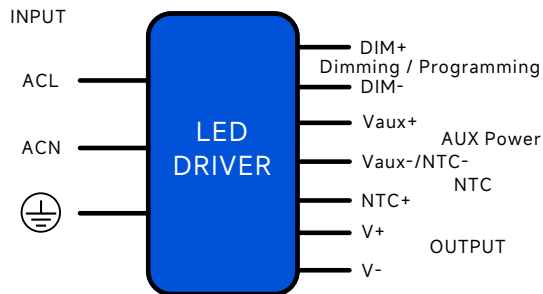

AC Input Cable(Exposed Length 450±10mm):

Global model: SOOW,3*17AWG,O.D: 9.8mm,Brown:L,Blue:N,Yellow/Green:⊕

DC O/P Cable(Exposed Length 250±10mm):

Global model: SOOW,2*17AWG,O.D: 9.3mm,Brown:V+ Blue:V-
Global model:SOOW,3*17AWG,O.D:9.8mm,Brown:V+,Blue:V-,
Yellow/Green:GND(Suffix-G) ⊕

BH Model DIM/AUX Power/Programming Cable (Exposed Length 220±10mm):

UL model: 21996, 4*22AWG , O.D: 5.6mm Purple DIM+, Pink: DIM-,
Black/White: Vaux+, Blue/White: Vaux-

BHN Model DIM/AUX Power/Programming/NTC Cable (Exposed Length 220±10mm):

UL model: 21996, 5*22AWG , O.D: 6.0mm Purple DIM+, Pink: DIM-,
Black/White: Vaux+, Blue/White: Vaux-/NTC-, Red/White: NTC+

SS-1200NP-ML500 Series LED Driver

Mechanical Characteristics

Name Description	Standard Code	mm(In.)
Case Length	L3	323(12.71)
Case Width	W1	89.5(3.53)
Case Height	H	44.5(1.75)
Overall Length	L1	350(13.78)
Mounting Hole Length	L2	336.5(13.25)
Mounting Hole Width	W2	40(1.57)
TC Point Position	X	160(6.30)
TC Point Position	Y	45(1.77)

Note

1, Please follow the "LED Driver User Manual" obtained from SOSEN's official website for assembly.

2, AC Input Cable, DC O/P Cable, DIM/AUX Power/Programming Cable:
Peeled length of cable: 43 ± 5 mm, Tinned length of wire: 10 ± 2 mm

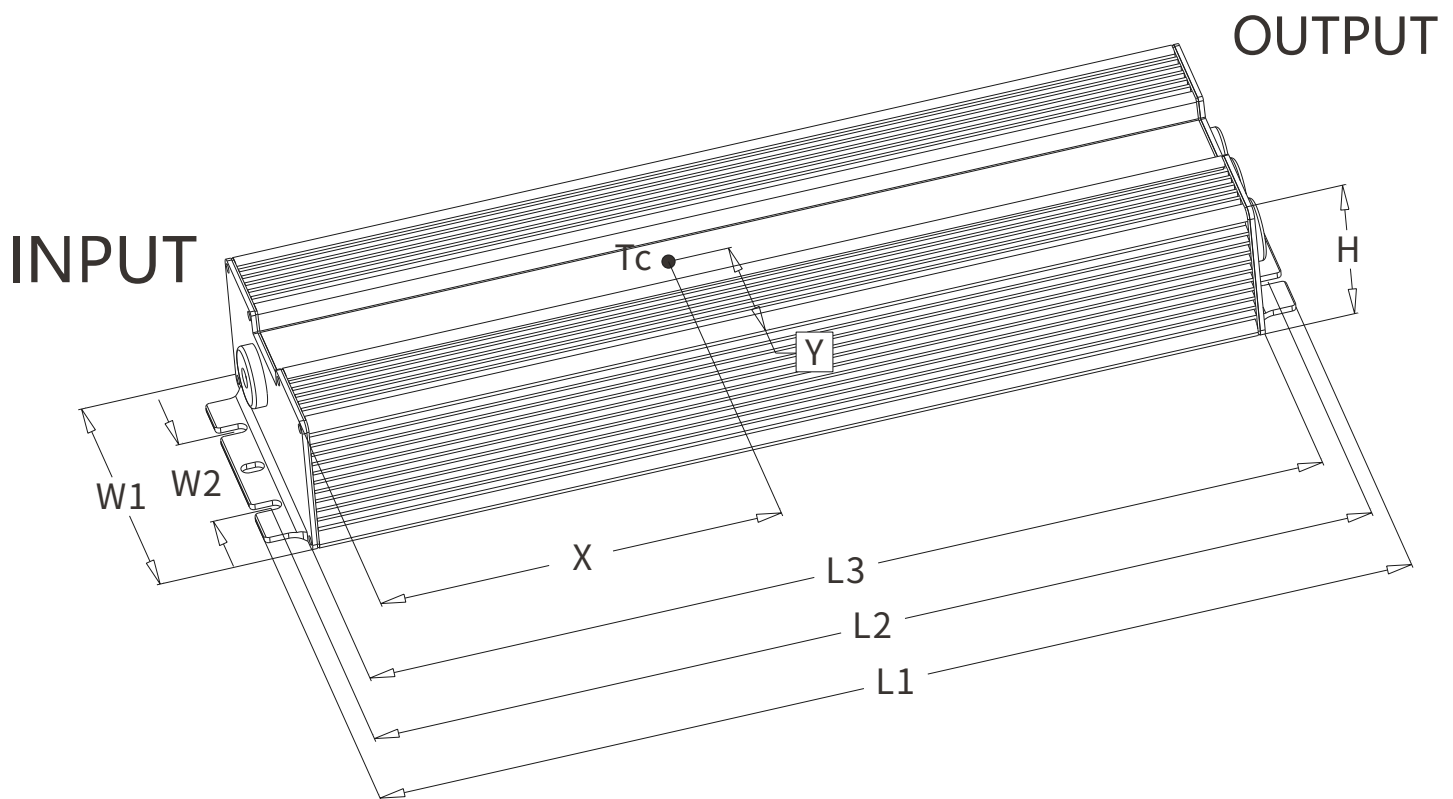

SS-1200NP-ML500 Series LED Driver



Assembly Tips

1. Dimming or AUX Power tinned connectors should be capped if not used to avoid dimming or AUX Power parts damage from external signals.
2. The trace routing on aluminum substrates is designed in compliance with creepage distance requirements specified by relevant certification regulations.
3. The creepage distance between LED+ and LED- on the aluminum substrate is designed in compliance with the relevant certification regulations.
4. Minimize the copper area on the aluminum PCB to reduce parasitic capacitance and leakage current.
5. It is recommended to design LED beads in parallel first and then in series.
6. The insulation level of LED light panels should meet the reliability design requirements.
7. It's recommended to add resistors or capacitors in parallel with the LED on PCB to reduce the risk of surge when a non isolated LED driver is used for the luminaire
8. For other precautions, please refer to the "LED Driver User Manual".

Warning

Insufficient or compromised insulation voltage resistance in LED light panels may cause breakdown and short circuits to earth, resulting in damage to the luminaire and LED driver, and posing significant safety hazards. It is recommended to install a residual current device (RCD) during application.

Package

- Outside carton dimension: L×W×H =495mm×385mm×162mm;
- 5PCS/Carton;
- Net weight/Piece: 2.705kg;Gross weight/Carton: 14.515kg;
- Please refer to the product name, model number, manufacturer identification, QC PASS, manufacturing date on the package.

Transportation

Packaging is designed suitable for transportation by trucks, vessels and flights. The products should be avoided direct sunlight and rain, loaded/unloaded with caution.

Storage

The product storage meets the standard of the GB 3873—83.
Products should be rechecked if stored for over 1 year before assembly.

RoHS

Products comply with RoHS Directive (2011/65/EU) and amendment 2015/863/EU.

Revision History

Version	Description of Update	Updated Date	Remark
V00	Original Release	2025/05/27	
V01	Add warning statements	2026/05/29	